

Washer-Extractors

Cabinet Freestanding

Refer to Page 3 for Model Identification

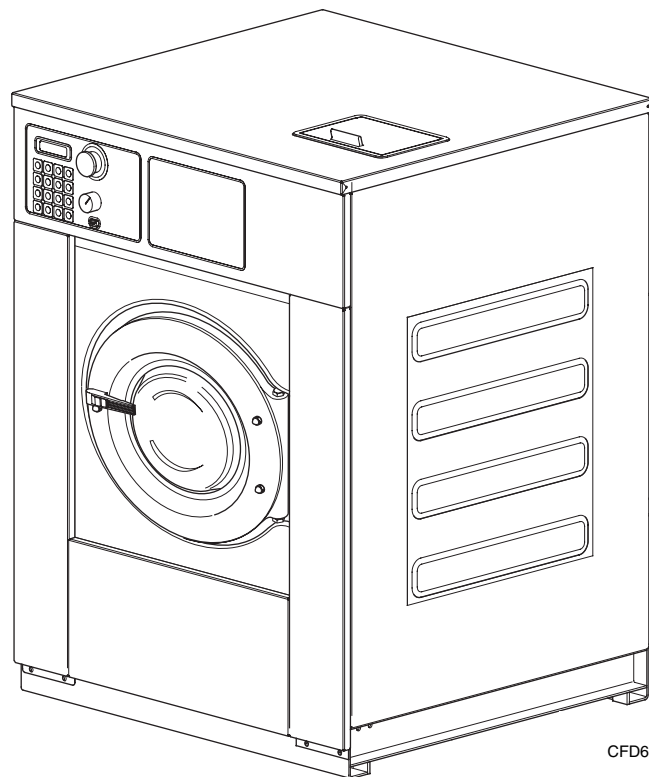

CFD6C

Para bajar una copia de estas instrucciones en español, visite www.comlaundry.com.

Keep These Instructions for Future Reference.

(If this machine changes ownership, this manual must accompany machine.)



www.comlaundry.com

Part No. 9001001R4
April 2007

— Operation/Maintenance —

Table of Contents

Introduction	3
Model Identification	3
Nameplate Location.....	5
Replacement Parts	5
Customer Service.....	5
Safety Information	7
Explanation of Safety Messages.....	7
Important Safety Instructions	7
Preliminary Information	9
About the Control	9
Power Failure Recovery	9
Control Identification.....	10
Operation	11
Load the Machine	11
Start a Program	12
Special Options in Run Mode.....	13
Advance Mode.....	13
Chemical Hold Feature	13
Stop the Machine	14
Error Messages	15
Maintenance	19
Daily	19
Weekly	20
Monthly.....	20
Yearly	21
Daily Preventive Maintenance Checklist.....	22
Weekly Preventive Maintenance Checklist.....	23
Monthly Preventive Maintenance Checklist.....	24
Yearly Preventive Maintenance Checklist.....	25

© Copyright 2007, Alliance Laundry Systems LLC

All rights reserved. No part of the contents of this book may be reproduced or transmitted in any form or by any means without the expressed written consent of the publisher.

Introduction

Model Identification

Information in this manual is applicable to these models:

18	HX18PVQM6 HX18PVQM7 HX18PVXM6 HX18PVXM7	SX18PVQM6 SX18PVQM7 SX18PVXM6 SX18PVXM7	UX18PVNA6 UX18PVNA7 UX18PVPA6 UX18PVPA7 UX18PVQA6 UX18PVQA7 UX18PVQM6 UX18PVQM7 UX18PVXA6 UX18PVXA7 UX18PVXM6 UX18PVXM7	HX18PVQU6 HX18PVXU6	SX18PVQU6 SX18PVXU6	UX18PVNU6 UX18PVPU6 UX18PVQU6 UX18PVXU6
25	HX25PVQM6 HX25PVQM7 HX25PVXM6 HX25PVXM7	SX25PVQM6 SX25PVQM7 SX25PVXM6 SX25PVXM7	UX25PVNA6 UX25PVNA7 UX25PVPA6 UX25PVPA7 UX25PVQA6 UX25PVQA7 UX25PVQM6 UX25PVQM7 UX25PVXA6 UX25PVXA7 UX25PVXM6 UX25PVXM7	HX25PVQU6 HX25PVXU6	SX25PVQU6 SX25PVXU6	UX25PVNU6 UX25PVPU6 UX25PVQU6 UX25PVXU6
35	HX35PVQM6 HX35PVQM7 HX35PVXM6 HX35PVXM7	SX35PVQM6 SX35PVQM7 SX35PVXM6 SX35PVXM7	UX35PVNA6 UX35PVNA7 UX35PVPA6 UX35PVPA7 UX35PVQA6 UX35PVQA7 UX35PVQM6 UX35PVQM7 UX35PVXA6 UX35PVXA7 UX35PVXM6 UX35PVXM7	HX35PVQU6 HX35PVXU6	SX35PVQU6 SX35PVXU6	UX35PVNU6 UX35PVPU6 UX35PVQU6 UX35PVXU6

continued

Introduction

continued

<p>55</p>				<p>HX55PVNU6 HX55PVNU7 HX55PVQU6 HX55PVQU7 HX55PVXU6 HX55PVXU7</p>	<p>SX55PVNU6 SX55PVNU7 SX55PVPU6 SX55PVPU7 SX55PVQU6 SX55PVQU7 SX55PVXU6 SX55PVXU7</p>	<p>UX55PVNU6 UX55PVNU7 UX55PVPU6 UX55PVPU7 UX55PVQU6 UX55PVQU7 UX55PVXU6 UX55PVXU7</p>
<p>75</p>				<p>HX75PVNU6 HX75PVNU7 HX75PVQU6 HX75PVQU7</p>	<p>SX75PVNU6 SX75PVNU7 SX75PVQU6 SX75PVQU7</p>	<p>UX75PVNU6 UX75PVNU7 UX75PVPU6 UX75PVPU7 UX75PVQU6 UX75PVQU7</p>
<p>100</p>				<p>HX100PVNU6 HX100PVNU7 HX100PVQU6 HX100PVQU7</p>	<p>SX100PVNU6 SX100PVNU7 SX100PVQU6 SX100PVQU7</p>	<p>UX100PVNU6 UX100PVNU7 UX100PVPU6 UX100PVPU7 UX100PVQU6 UX100PVQU7</p>
<p>135</p>				<p>HX135PVNU6 HX135PVNU7 HX135PVQU6 HX135PVQU7</p>	<p>SX135PVNU6 SX135PVNU7 SX135PVQU6 SX135PVQU7</p>	<p>UX135PVNU6 UX135PVNU7 UX135PVPU6 UX135PVPU7 UX135PVQU6 UX135PVQU7</p>
<p>165</p>				<p>HX165PVNU6 HX165PVNU7 HX165PVQU6 HX165PVQU7</p>	<p>SX165PVNU6 SX165PVNU7 SX165PVQU6 SX165PVQU7</p>	<p>UX165PVNU6 UX165PVNU7 UX165PVPU6 UX165PVPU7 UX165PVQU6 UX165PVQU7</p>

Nameplate Location

The nameplate is located at the rear of the machine. Always provide the machine's serial number and model number when ordering parts or when seeking technical assistance.

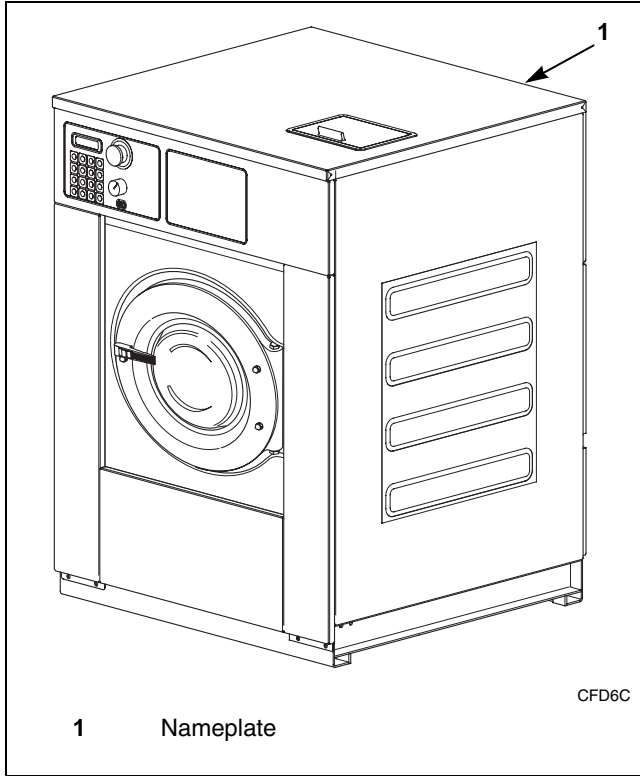

Figure 1

Replacement Parts

If literature or replacement parts are required, contact the source from which the machine was purchased or contact Alliance Laundry Systems at (920) 748-3950 for the name and address of the nearest authorized parts distributor.

Customer Service

For technical assistance, call (920) 748-3121.

Introduction

Model Number Familiarization Guide	
Sample Model Number: *X55PVXM60001	
*X	Model Number Prefix
55	Washer-Extractor Capacity (pounds dry weight of laundry)
P	Type of Electrical Control (P = WE-6 Computer)
V	Washer-Extractor Speed Capabilities
X	Electrical Characteristics
M6	Design Series
0001	Option Identification (varies from machine to machine)

* Denotes Brand

Model No.	*X55PVXM60001					
Serial No.	0000000000					
Voltage	200-240/50-60/1-3	Amps	12			
Required Circuit Breaker	Amps		15			
Hz	50-60	Wire	2/3+PE		Phase	1/3
Max. Load	55 LB	25 KG	Max. Speed		1000	RPM
Elec. Heating		KW	Steam Press.	PSI	BAR	

EXAMPLE OF NAMEPLATE

CFD29N

Figure 2

Safety Information

Explanation of Safety Messages

Throughout this manual and on machine decals, you will find precautionary statements (“DANGER,” “WARNING,” and “CAUTION”) followed by specific instructions. These precautions are intended for the personal safety of the operator, user, servicer, and those maintaining the machine.

	DANGER
Indicates an imminently hazardous situation that, if not avoided, will cause severe personal injury or death.	

	WARNING
Indicates a hazardous situation that, if not avoided, could cause severe personal injury or death.	

	CAUTION
Indicates a hazardous situation that, if not avoided, may cause minor or moderate personal injury or property damage.	

Additional precautionary statements (“IMPORTANT” and “NOTE”) are followed by specific instructions.

IMPORTANT: The word “IMPORTANT” is used to inform the reader of specific procedures where minor machine damage will occur if the procedure is not followed.

NOTE: The word “NOTE” is used to communicate installation, operation, maintenance or servicing information that is important but not hazard related.

Important Safety Instructions

	WARNING
To reduce the risk of fire, electric shock, serious injury or death to persons when using your washer, follow these basic precautions:	
<small>W023</small>	

1. Read all instructions before using the washer.
2. Refer to the GROUNDING INSTRUCTIONS in the INSTALLATION manual for the proper grounding of the washer.
3. Do not wash textiles that have been previously cleaned in, washed in, soaked in, or spotted with gasoline, dry-cleaning solvents, or other flammable or explosive substances as they give off vapors that could ignite or explode.
4. Do not add gasoline, dry-cleaning solvents, or other flammable or explosive substances to the wash water. These substances give off vapors that could ignite or explode.
5. Under certain conditions, hydrogen gas may be produced in a hot water system that has not been used for two weeks or more. HYDROGEN GAS IS EXPLOSIVE. If the hot water system has not been used for such a period, before using a washing machine or combination washer-dryer, turn on all hot water faucets and let the water flow from each for several minutes. This will release any accumulated hydrogen gas. The gas is flammable, do not smoke or use an open flame during this time.
6. Do not allow children to play on or in the washer. This appliance is not intended for use by young children or infirm persons without supervision. Young children should be supervised to ensure that they do not play with the appliance.
7. Before the washer is removed from service or discarded, remove the door to the washing compartment.
8. Do not reach into the washer if the wash drum is moving.

Safety Information

9. Do not install or store the washer where it will be exposed to water and/or weather.
10. Do not tamper with the controls.
11. Do not repair or replace any part of the washer, or attempt any servicing unless specifically recommended in the user-maintenance instructions or in published user-repair instructions that the user understands and has the skills to carry out.
12. To reduce the risk of an electric shock or fire, DO NOT use an extension cord or an adapter to connect the washer to the electrical power source.
13. Use washer only for its intended purpose, washing textiles.
14. ALWAYS disconnect the washer from electrical supply before attempting any service. Disconnect the power cord by grasping the plug, not the cord.
15. Install the washer according to the **INSTALLATION INSTRUCTIONS**. All connections for water, drain, electrical power and grounding must comply with local codes and be made by licensed personnel when required.
16. To reduce the risk of fire, textiles which have traces of any flammable substances such as vegetable oil, cooking oil, machine oil, flammable chemicals, thinner, etc., or anything containing wax or chemicals such as in mops and cleaning cloths, must not be put into the washer. These flammable substances may cause the fabric to catch on fire by itself.
17. Do not use fabric softeners or products to eliminate static unless recommended by the manufacturer of the fabric softener or product.
18. Keep washer in good condition. Bumping or dropping the washer can damage safety features. If this occurs, have washer checked by a qualified service person.
19. Replace worn power cords and/or loose plugs.
20. Be sure water connections have a shut-off valve and that fill hose connections are tight. CLOSE the shut-off valves at the end of each wash day.
21. Loading door **MUST BE CLOSED** any time the washer is to fill, tumble or spin. **DO NOT** bypass the loading door switch by permitting the washer to operate with the loading door open.
22. Always read and follow manufacturer's instructions on packages of laundry and cleaning aids. Heed all warnings or precautions. To reduce the risk of poisoning or chemical burns, keep them out of the reach of children at all times (preferably in a locked cabinet).
23. Always follow the fabric care instructions supplied by the textile manufacturer.
24. Never operate the washer with any guards and/or panels removed.
25. **DO NOT** operate the washer with missing or broken parts.
26. **DO NOT** bypass any safety devices.
27. Failure to install, maintain, and/or operate this washer according to the manufacturer's instructions may result in conditions which can produce bodily injury and/or property damage.

NOTE: The WARNINGS and IMPORTANT SAFETY INSTRUCTIONS appearing in this manual are not meant to cover all possible conditions and situations that may occur. Common sense, caution and care must be exercised when installing, maintaining, or operating the washer.

Any problems or conditions not understood should be reported to the dealer, distributor, service agent or the manufacturer.

Preliminary Information

About the Control

WE-8 computer on the washer-extractor is an advanced, programmable computer that allows the owner to create wash programs.

The control is factory set-up with 42 pre-programmed cycles and is ready for operation. Refer to *Pre-Programmed Cycles* section in the Programming manual.

WE-8 allows the owner to program custom cycles on the machine or with a PC and the Alliance planner software.

IMPORTANT: In the event of a power failure, WE-8 will not have to be reprogrammed. It is designed with a memory system that will remember how it was programmed until the electrical power is restored.

Power Failure Recovery

If a cycle is in process and the power fails, cycle status is saved in memory without power being applied.

If power resumes, the control will enter into the Start Mode at the beginning of the cycle step where the power failed.

Control Identification

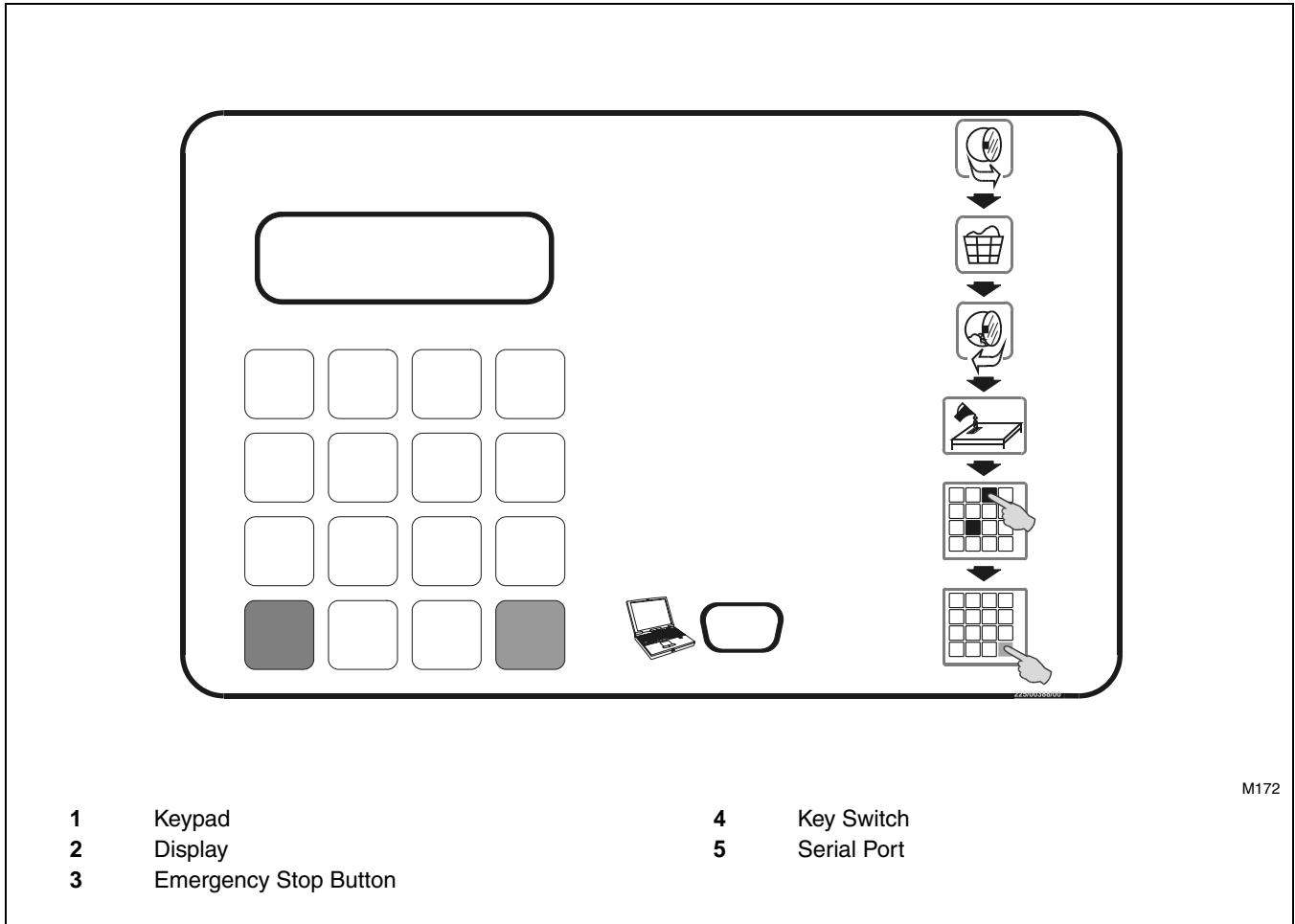

Figure 3

Operation

Load the Machine

For 18 - 75 models:

Push the black button and pull the door handle towards you to open the door.

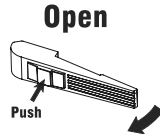

M179A

Figure 4

Load the drum to the specified capacity.

Close the door by pushing the door handle towards the machine.

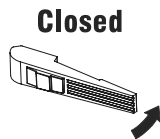

M179B

Figure 5

For 100 - 165 models:

Push on the doorlock system to open the door.

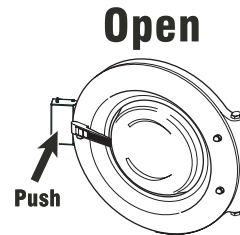

CFD63N

Figure 6

Load the drum to the specified capacity.

Close the door by pushing the door handle towards the machine.

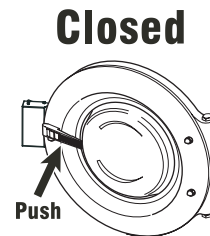

CFD64N

Figure 7

Operation

Start a Program

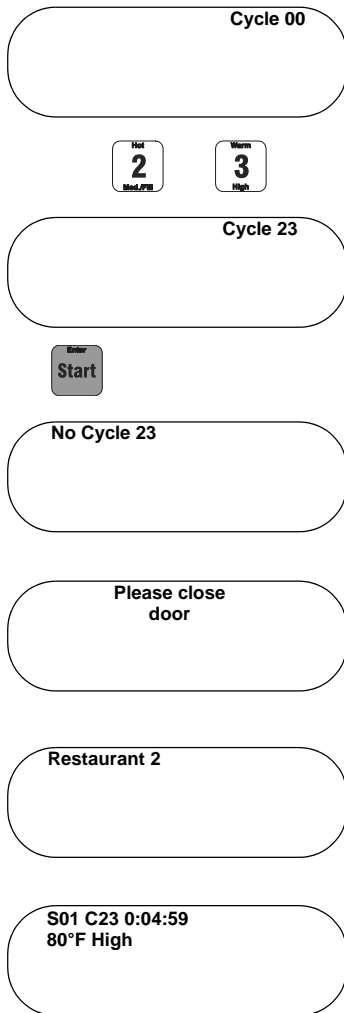

After powering up the control, “Cycle 00” will show on the display.

Press the desired program number (example: program 23).

The display will show the cycle (example: “Cycle 23”).

Press “Start” to run the program.

If the program does not exist, the display will show “No Cycle 23”. See program mode to create a program.

If the door is not closed, the display will show “Please close door”. After closing the door the program will start.

If the door is closed and the program exists, the program will start. The name of the program will show on the display for 2 seconds and the machine will start.

When the machine is started the display will show the following information.

S01: Step 1

C23: Program number 23

0:04:59: The time of step 1. This will count down to 0 and then go to step 2 (S02).

80°F: The temperature of the bath that is programmed.

High: The water level in step 1 that is programmed.

Special Options in Run Mode

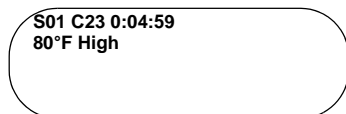
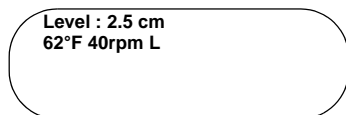
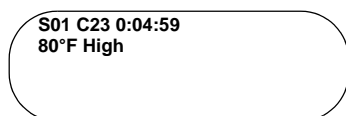

While the machine is running press the “Display Temp” button.

Level: 2.5 cm: Water level in the bath. If the machine is filling with water this value will increase. If in a drain step this value will decrease.

62°F: The water temperature.

40rpm: The measured rpm of the drum.

L: Rotation direction of the drum
L (left), R (right)

Press the “Display Temp” button to go back.

Advance Mode

Press the “Advance” button to proceed to the next step in the program.

Chemical Hold Feature

Chemical supply injection can be paused. Refer to section *Setup of the Chemical Hold Feature* in Programming manual.

Operation

Stop the Machine



Press the Stop button.

If there is water in the machine the display will show “Waterlevel xx.x cm” while the machine is draining the water.

If the machine is spinning the display will show “Coast down”.

When the water is out and the drum has stopped moving the display will flash between “Please open door” and “Done cycle 23” until the door is open.

Error Messages

Door error

Door Error

If the door is closed after start the control will try to lock the door. If the door will not lock “Door error” will display.

Possible Faults:

- Wiring is not connected properly.
- Coil to lock the door has failed.
- Mechanical problem on the door lock.

Didn't fill
within time

Fill Alarm

If machine does not reach programmed water level within time programmed for step, a fill alarm occurs. Machine will continue filling and agitating, while sounding beeper and flashing “Didn't fill within time” on display.

Enter to retry
Clear to stop

Condition will continue for up to two (2) minutes. If programmed water level is reached before two minute fill alarm time ends, condition ends, and machine resumes operation. If Enter key is pressed during fill alarm, condition will end and step will start over. If programmed water level is not reached within programmed step time, fill alarm will occur again. If Clear (STOP) key is pressed while fill alarm is in effect, cycle will end, and door will unlock. If no action is taken, and fill level is not reached within two minute alarm time limit, cycle will end and door can be unlocked (provided no water level is sensed). Whenever a fill alarm occurred during a cycle, display will repeat following messages at end of stop routine, before door is opened, to indicate alarm condition occurred in cycle.

Done Cycle CC

Please open door

Didn't fill
within time

During step N

(CC = cycle number;
N = step number in which the
alarm occurred).

Fill Alarm (Continued)

Possible Faults:

- Wiring is not connected properly to the inlet valves.
- The inlet valve is broken.
- There is a problem with the water supply.
- The inlet valves are blocked by dirt.
- The water pressure hose is broken or not connected properly.

Didn't drain within time

Enter to retry
Clear to stop

Drain Alarm

If drain step is NOT followed by a spin and if machine does not empty within the time programmed for drain step, a drain alarm occurs. Display will read "Didn't drain within time."

Done Cycle CC

Please open door

Didn't drain within time

During step N

During drain alarm, beeper sounds on and off, and machine continues attempting to drain. If machine does not empty, condition continues. If Enter key is pressed, drain alarm ends, and drain step starts over at beginning. If machine has not emptied when drain step time expires, alarm occurs again. If Clear (STOP) key is pressed while drain alarm is in effect, display shows water level (inches or centimeters), but otherwise takes no new action since machine has not emptied.

When cycle ends, display repeats following messages briefly until door is opened (to indicate that an alarm condition occurred in the cycle):

If machine drains during a spin step prior to accelerating into high speed and if machine has not emptied within approximately 2 minutes of starting drain procedure, a drain alarm occurs. There is no rotation during this alarm; messages displayed are identical to drain alarm during a drain step not followed by a spin. Pressing Enter (START) during drain alarm in a spin step ends alarm and begins spin step again at start, with machine rotating at wash speed forward, then to distribution speed. After drain begins (i.e., drain open, pumping begins), if 2 additional minutes elapse, alarm occurs again.

(CC = cycle number;
N = step number in which the alarm occurred).

Temperature
sensor error

If there was a problem during heating in a step at the end of the program, the control will show “Temperature sensor error”. The temperature was never reached in this cycle.

Possible Faults:

- Bad temperature probe.
- Wiring to electrical or steam heating relay has failed.
- Electrical heating elements or steam valve is broken.

NOTE: If the cycle aborted, it may be due to a temperature sensor error.

Rotation
sensor error

The control did not sense any pulses or the control sensed wrong pulses from the rpm sensor.

Possible Faults:

- Rpm sensor is broken.
- Distance from rpm sensor to pulley is too large (>2mm).
- Bad motor.
- V-belt is broken.
- Problems with the inverter.
- Wiring connection is bad.

Speed detection
error

An error occurred at the end of a spin stop or during coast down, where the rpm sensor suddenly failed to give output pulses.

Possible Faults:

- Rpm sensor failure.
- Rpm sensor dislocated (too far from pulley).
- Broken V-belt.
- Wiring disconnected.

Maintenance

Routine maintenance maximizes operating efficiency and minimizes downtime. The maintenance procedures described below will prolong the life of the machine and help prevent accidents.

	CAUTION
<p>Replace all panels that are removed to perform service and maintenance procedures. Do not operate the machine with missing guards or with broken or missing parts. Do not bypass any safety devices.</p>	
<small>SW019</small>	

Daily, weekly, monthly, and yearly checklists are provided at the end of this section. Laminate the checklists to preserve them for repeated copying. Operators and technicians are encouraged to add checks specific to their machine's particular application. When possible, space is provided on the checklists for this purpose.

The following maintenance procedures must be performed regularly at the required intervals.

Daily

Beginning of the day

1. Inspect water inlet valve hose connections on the back of the machine for leaks.
2. Inspect steam hose connections for leaks, where applicable.
3. Verify that insulation is intact on all external wires and that all connections are secure. If bare wire is evident, call a service technician.
4. Check door interlock before starting operation:
 - a. Attempt to start the washer with the door open. The washer should not start with the door open.
 - b. Close the door and start the machine. Attempt to open the door while the cycle is in progress. The door should not open.

IMPORTANT: If the door lock and interlock are not functioning properly, take machine out of service. Call a service technician to correct.

Maintenance

End of day

1. Clean the fan of the AC drive box.
2. Clean the entire cabinet of the machine regularly and remove all traces of soap, etc.
3. Remove all detergent residue in the soap dispenser with hot water.
4. Clean the door gasket and remove all detergents and other products.
5. Shut off the main water, steam and power connections at the end of each day. Do not change the setting of the water inlet taps on boiler fed machines once these have been installed.
6. It is recommended to leave the door and the soap dispenser open after use, to ventilate the machine.

NOTE: Unload the machine promptly after each completed cycle to prevent moisture buildup. Leave loading door open at the end of each completed cycle to allow moisture to evaporate.

Weekly

1. Check the machine for leaks.
 - a. Start an unloaded cycle to fill the machine.
 - b. Verify that door and door gasket do not leak.
 - c. Verify that the drain valve is operating. If water does not leak out during the prewash segment, drain valve is closed and functioning properly.

Monthly

NOTE: Disconnect power to the machine at its source before performing the monthly maintenance procedures.

1. Clean the AC drive Box.
 - a. Remove the AC drive box cover.
 - b. Blow the fins clean using compressed air at a pressure of 60-90 psi or by using canned compressed air. Use care to avoid damaging cooling fan or other components.
2. V-belts.
 - a. Check V-belts for uneven wear and frayed edges.
 - b. Verify that V-belts are properly aligned by checking pulley alignment. Place a straightedge across both pulley faces. The straightedge should make contact with the pulleys in four places.

3. Remove back panel and check overflow hose and drain hose for leaks.
4. Clean inlet hose filter screen:
 - a. Turn water off and allow valve to cool, if necessary.
 - b. Unscrew inlet hose and remove filter screen.
 - c. Clean with soapy water, rinse and reinstall. Replace if worn or damaged.
5. Check the supply dispenser hoses for leaks.
6. Use compressed air to clean lint from motor.
7. Clean interior of machine, both basket and shell, by wiping with a water-soaked sponge or cloth.
8. Use compressed air to ensure that all electrical components are free of moisture and dust.

Yearly

1. Replace the automatic lubricator (only for 75-100-135-165 machine). Failure to do so could void the warranty.
2. Check if the machine is working properly. If you see or hear any abnormal function on the machine call a service technician.

Daily Preventive Maintenance Checklist

Machine _____	Week of: _____						
Operator _____	Days						
Checks	1	2	3	4	5	6	7
Beginning of Day							
1. Inspect water inlet valve hose connections on the back of the machine for leaks.							
2. Inspect steam hose connections for leaks, where applicable.							
3. Verify that insulation is intact on all external wires and that all connections are secure.							
4. Inspect door lock and interlock before starting operation:							
a. Attempt to start the machine with door open.							
b. Close the door and start the machine. Attempt to open the door while the cycle is in progress.							
5.							
End of Day							
1. Clean the fan of the AC drive box.							
2. Clean the entire cabinet of the machine.							
3. Remove all detergent residue in the soap dispenser with hot water.							
4. Clean the door gasket and remove all detergents and other products.							
5. Shut off the main water, steam and power.							
6. Leave loading door open at the end of each day to ventilate the machine.							
7.							
<p>NOTE: Unload the machine promptly after each completed cycle to prevent moisture buildup.</p> <p>NOTE: Leave loading door open after each completed cycle to allow moisture to evaporate.</p>							

Weekly Preventive Maintenance Checklist

Machine _____	Month _____				
Operator _____	Week Ending:				
Checks	/	/	/	/	/
1. Check the machine for leaks:					
a. Start an unloaded cycle to fill the machine.					
b. Verify that door and door gasket do not leak.					
c. Verify that the drain valve is operating.					
2.					
3.					
4.					
5.					
6.					
7.					

Maintenance

Monthly Preventive Maintenance Checklist

Machine _____ Operator _____	Month			
Checks				
Observe All Safety Warnings! Disconnect power to the machine before performing the monthly maintenance procedures.				
1. Clean the AC drive box.				
2. V-belts				
a. Check V-belts for uneven wear and frayed edges.				
b. Verify that V-belts are properly aligned by checking pulley alignment.				
3. Remove back panel and check overflow hose and drain hose for leaks.				
4. Clean inlet hose filter screen.				
5. Check the supply dispenser hoses for leaks.				
6. Use compressed air to clean lint from motor.				
7. Clean interior of machine, both basket and shell, by wiping with a water-soaked sponge or cloth.				
8. Use compressed air to ensure that all electrical components are free of moisture and dust.				
9.				
10.				

Yearly Preventive Maintenance Checklist

Machine _____	Year			
Operator _____				
Checks				
Observe All Safety Warnings! Disconnect power to the machine before performing the quarterly maintenance procedures.				
1. Replace the automatic lubricator (only for 75-100-135-165 machines).				
2. Check if the machine is working properly. If you see or hear any abnormal function on the machine call a service technician.				
3.				
4.				
5.				
6.				
7.				
8.				
9.				

